

**INSTRUCTION MANUAL
ROTATING LASER**

RL-200 2S

Foreword

Thank you for purchasing the Topcon RL-200 2S Rotating Laser.

It is one of the world's most advanced and accurate grade-setting lasers. To quickly and effectively use the RL-200 2S, please read these brief instructions carefully, and keep them in a convenient location for future reference.

Precautions

Guarding the instrument against shock

When transporting the instrument, provide some protection to minimize risk of shock. Heavy shocks may affect beam accuracy.

Sudden changes of temperature

A sudden change in temperature may cause water condensation on the glass used for the laser emission part.

In such a case, let the instrument stand for a while to allow it to adjust to the temperature prior to actual use.



Caution:



Use of adjustment controls or performance procedures other than those specified herein may result in hazardous radiation exposure.

Precautions for Safe Operation

For the safe use of the product and prevention of injury to operators and other persons as well as prevention of property damage, items which should be observed are indicated by an exclamation point within a triangle used with WARNING and CAUTION statements in this instruction manual. The definitions of the indications are listed below. Be sure you understand them before reading the manual's main text.

Definition of Indication

	WARNING	Ignoring this indication and making an operation error could possibly result in death or serious injury to the operator.
	CAUTION	Ignoring this indication and making an operation error could possibly result in personal injury or property damage.

-  This symbol indicates items for which caution (hazard warnings inclusive) is urged. Specific details are printed in or near the symbol.
-  This symbol indicates items which are prohibited. Specific details are printed in or near the symbol.
-  This symbol indicates items which must always be performed. Specific details are printed in or near the symbol.



Warning



Do not perform disassembly or rebuilding. Fire, electric shock or burns could result.



Do not use the unit in areas exposed to high amounts of dust or ash, in areas where there is inadequate ventilation, or near combustible materials. An explosion could occur.



When securing the instrument in the carrying case make sure that all catches, including the side catches, are closed. Failure to do so could result in the instrument falling out while being carried, causing injury.



Caution



Do not use the carrying case as a footstool. The case is slippery and unstable so a person could slip and fall off it.



Do not place the instrument in a case with a damaged case or belt. The case or instrument could be dropped and cause injury.



Warning



Do not short circuit. Heat or ignition could result.



Do not use voltage other than the specified power supply voltage. Fire or electrical shock could result.



Do not use damaged power cords, plugs or loose outlets. Fire or electric shock could result.



Do not use power cords other than those designated. Fire could result.



Do not use batteries other than those designated. An explosion could occur, or abnormal heat generated, leading to fire.







Do not place articles such as clothing on the battery charger while charging batteries. Sparks could be induced, leading to fire.



Use only the specified battery charger to recharge batteries. Other chargers may be of different voltage rating or polarity, causing sparking which could lead to fire or burns.



Do not heat or throw batteries into fire. An explosion could occur, resulting in injury.

-  Do not use the battery or charger for any other equipment or purpose. Fire or burns caused by ignition could result.
-  To prevent shorting of the battery in storage, apply insulating tape or equivalent to the terminals. Otherwise shorting could occur, resulting in fire or burns.
-  Do not use batteries or the battery charger if wet. Resultant shorting could lead to fire or burns.
-  Do not connect or disconnect power supply plugs with wet hands. Electric shock could result.

 **Caution**

-  Do not touch liquid leaking from batteries. Harmful chemicals could cause burns or blisters.



Caution



When mounting the instrument to the tripod, tighten the centering screw securely. Failure to tighten the screw properly could result in the instrument falling off the tripod, causing injury.



Tighten securely the leg fixing screws of the tripod on which the instrument is mounted. Failure to tighten the screws could result in the tripod collapsing, causing injury.



Do not carry the tripod with the tripod shoes pointed at other persons. A person could be injured if struck by the tripod shoes.



Keep hands and feet away from the tripod shoes when fixing the tripod in the ground. A hand or foot stab wound could result.



Tighten the leg fixing screws securely before carrying the tripod. Failure to tighten the screws could lead to the tripod legs extending, causing injury.

User

Wear the required protectors (safety shoes, helmet, etc.) when operating.

Exceptions from Responsibility

- The user of this product is expected to follow all operating instructions and make periodic checks of the product's performance.
- The manufacturer, or its representatives, assumes no responsibility for results of a faulty or intentional usage or misuse including any direct, indirect, consequential damage, and loss of profits.
- The manufacturer, or its representatives, assumes no responsibility for consequential damage, and loss of profits by any disaster, (an earthquake, storms, floods etc.). A fire, accident, or an act of a third party and/or a usage any other usual conditions.
- The manufacturer, or its representatives, assumes no responsibility for any damage, and loss of profits due to a change of data, loss of data, an interruption of business etc., caused by using the product or an unusable product.
- The manufacturer, or its representatives, assumes no responsibility for any damage, and loss of profits caused by usage except for explained in the user manual.
- The manufacturer, or its representatives, assumes no responsibility for damage caused by wrong movement, or action due to connecting with other products.

Laser Safety Information

The RL-200 2S is classified as a class 3R Laser Product according to IEC Standard Publication 60825-1 Ed.2.0: 2007 and United States Government Code of Federal Regulation FDA CDRH 21CFR Part1040.10 and 1040.11 (Complies with FDA performance standards for laser products except for deviations pursuant to Laser Notice No.50, dated June 24, 2007.)

Laser Safety

This product projects a visible laser beam during operation. This product is manufactured and sold in accordance with “Performance Standards for Light-Emitting Products” (FDA/BRH 21 CFR 1040) or “Radiation Safety of Laser Products, Equipment Classification, Requirements and User’s Guide” (IEC Publication 60825-1) provided on the safety standards for laser beam.

As per the said standard, RL-200 2S standard model is classified as “Class 3R (IIIa) Laser Products”. These are simple products to operate and do not require training from a laser safety officer. In case of any failure, do not disassemble the instrument. Contact TOPCON or your TOPCON dealer.

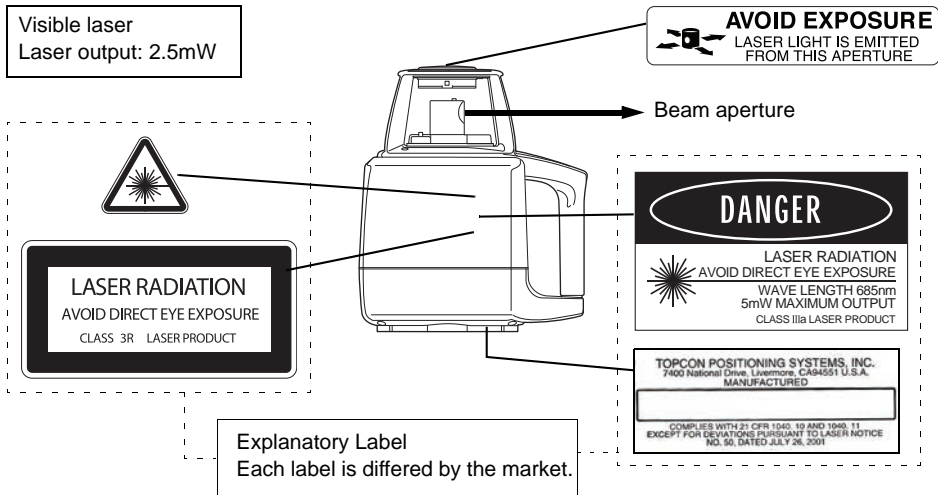

Warning

- Use of controls or adjustments or performance of procedures other than those specified herein may result in hazardous radiation exposure.

- Never intentionally point the laser beam at another person. The laser beam is injurious to the eyes and skin.
- Do not look directly into the laser beam. Doing so could cause permanent eye damage.
- Do not stare at the laser beam. Doing so could cause permanent eye damage.
- Never look at the laser beam through a telescope, binoculars or other optical instruments. Doing so could cause permanent eye damage.
- Sight targets so that the laser beam does not stray from them.

Caution

- Perform checks at start of work and periodic checks and adjustments with the laser beam emitted under normal conditions.
- When disposing of the instrument, destroy the battery connector so that the laser beam cannot be emitted.
- Operate the instrument with due caution to avoid injuries that may be caused by the laser beam unintentionally striking a person in the eye. Avoid setting the instrument at heights at which the path of the laser beam may strike pedestrians or drivers at head height.

- Only those who have received training as per the following items shall use this product.
 - Read the manual for usage procedures for this product.
 - Hazardous protection procedures (read "Laser Safety Information")
 - Requisite protective gear (read "Laser Safety Information")
 - Accident reporting procedures (stipulate procedures beforehand for transporting the injured and contacting physicians in case there are laser-induced injuries).
- When the instrument is not being used, turn off the power.

Standard System Components

Rechargeable battery type

1) Instrument.....	1pc.
2) Remote controller RC-400.....	1pc.
3) Level Sensor LS-80L.....	1pc.
4) Level Sensor Holder Model-6.....	1pc.
5) Battery holder DB-75C.....	1pc.
6) Ni-MH battery pack BT-67Q.....	1set
7) AC/DC converter AD-11.....	1pc.
8) AA-size dry cell batteries ^{*1)}	5pcs.
9) Carrying case.....	1pc.
10) Instruction manual.....	1vol.

Dry battery type

1) Instrument.....	1pc.
2) Level Sensor LS-80L.....	1pc.
3) Level Sensor Holder Model-6.....	1pc.
4) Battery holder DB-75.....	1pc.
5) D-size dry cell batteries ^{*2)}	4pcs.
6) AA-size dry cell batteries ^{*3)}	2pcs.
7) Carrying case.....	1pc.
8) Instruction manual.....	1vol.

- Please make sure that all of above items are in the box when you unpack.

*1), *2), *3) Batteries included in the package are to confirm the initial operation. Please replace the batteries provided with new batteries (alkaline) as soon as possible.

Contents

Foreword	1
Precautions	1
Precautions for Safe Operation	2
User	7
Exceptions from Responsibility	7
Laser Safety Information	8
Standard System Components	12
Contents	13
Nomenclature	15
Sample Display	17
Key Functions	18
RL-200 2S LED Display	18
Basic Operation	19
Preparation and Functions	20
Power Source	20
Setting Up Instrument	20
RC-400 Remote Controller	21
Power Switch	23
Battery Status Display	25
Setting Grades	26
Aligning Direction of Grade	27
How to Enter Grade	28
Menu	29

How to Set the Menu.....	29
Maintaining Power Sources	37
How to Change Batteries on the Instrument	37
How to Replace the RC-400 Batteries	41
Check and Adjusting	42
Horizontal Calibration.....	42
Horizontal Rotation Cone Error	46
Grade Setting Error	47
Storage Precautions.....	49
Standard Accessories	50
Specifications	55
Error Display	57
Regulations	59

Nomenclature

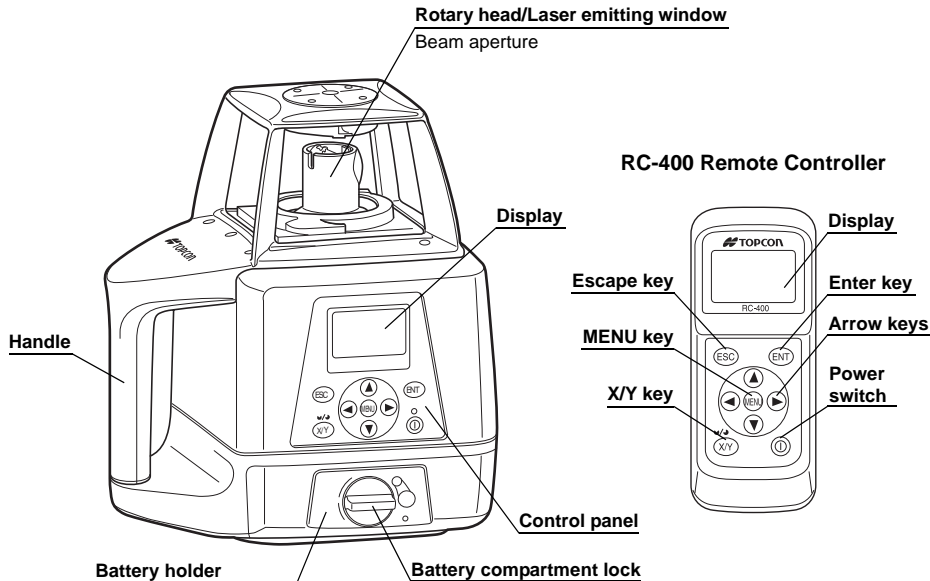

Control panel

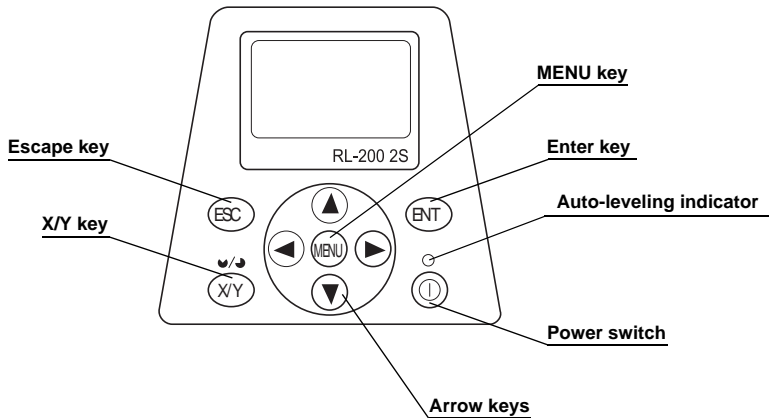

Sample Display

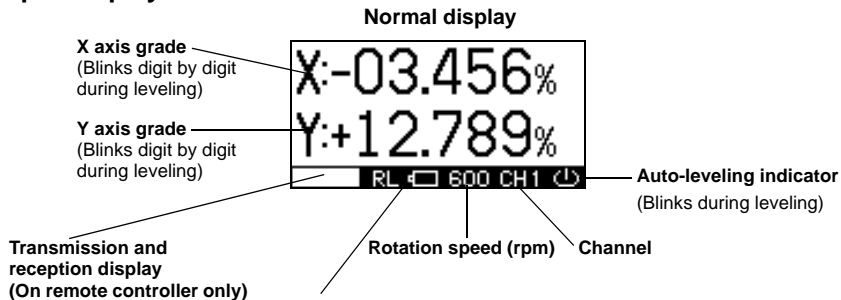

Battery remaining





Rotating laser display: RL
Remote controller display: RC

Menu screen display



See "Menu" on page 29.

Key Functions

	Enter key	End Operation of Data Input and Sends data to the instrument.
	Escape key	Cancels input or escape to previous status.
	X/Y key	Sets each grade axis.
	Menu and arrow keys	Selects menu items. Inputs the grades of X Y axis. Sets the masking direction.
	Power switch	On/Off of the RL-200 2S and RC-400. (RC-400 has auto-cut off 60 seconds function)

RL-200 2S LED Display

There is an LED that signals auto-leveling of the control panel screen of the main instrument.

Flashing : Auto-leveling or grade setting is in process.

The rotary head is not rotating.

ON solid : Auto-leveling grade setting is complete.

The rotary head is active and emits the laser beam.



You can stop the auto-levelling function. Refer to “4) Sensitivity Level” on page 34 to stop the function.

Basic Operation

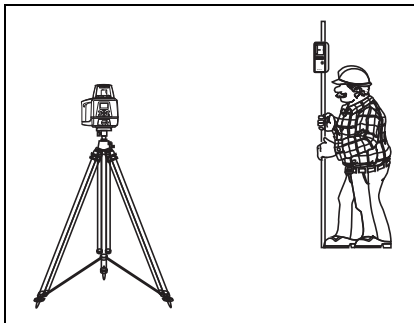

Normal precision mode

High precision mode

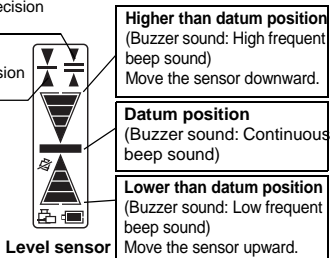

Higher than datum position
(Buzzer sound: High frequent beep sound)
Move the sensor downward.

Datum position
(Buzzer sound: Continuous beep sound)

Lower than datum position
(Buzzer sound: Low frequent beep sound)
Move the sensor upward.

- 1** Set the instrument on a tripod or smooth surface and turn on the power.

When using the remote controller, turn on the power for the instrument, and then the power for the remote controller.

- 2** Set X and/or Y axis grades.
- 3** Turn on the level sensor. Check the operation surface by using the level sensor. If high-precision detection is desired, select that setting on the level sensor.
- 4** Check the rotating beam elevation using the level sensor.

(For more information about level sensor refer to “Level Sensor LS-80L” on page 51 section.)

Preparation and Functions

Power Source

Connect the battery according to the battery type purchased.

For charging and battery replacement instructions, see the “Maintaining Power Sources” on page 37 section.

Setting Up Instrument

Set the instrument on a tripod or smooth surface.

The instrument must be within horizontal ± 5 degrees of true level for auto-leveling to operate.

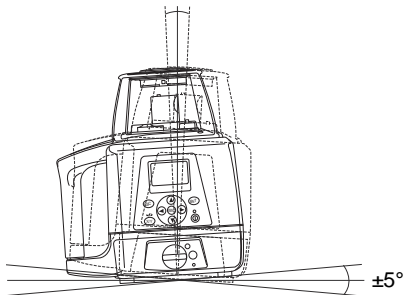

RC-400 Remote Controller

When using the remote controller, turn on the power for the instrument, and then the power for the remote controller.

Key operation

Press the [ENT] key after each key operation to lock the entry.

There will be interactive transmission between the instrument and the remote controller.

When the [ENT] key is pressed, entered information is transmitted from the remote controller to the instrument. When information is received by the instrument, it sends out signal of its confirmation to the remote controller.

Please check the display to make sure that the entry is correctly performed. (It will not be displayed on the display screen of the instrument.)

Transmission and reception display



Transmitting



Complete



Incomplete

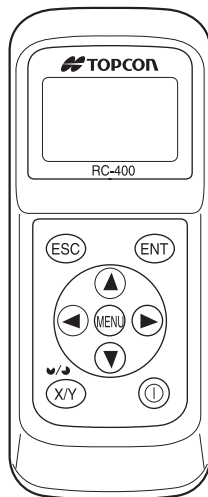



- 1) The working range of the remote controller is up to a distance of about 300 m from the instrument.
- 2) It is necessary to install batteries when using the remote controller. Install the batteries by referring to “How to Replace the RC-400 Batteries” on page 41.
- 3) The power of the remote controller shuts off automatically after about 60 seconds when key or leveling operations have been completed (Auto-Cut Off Function). Press the power switch once to restore power to the remote controller after the auto-cut off function has been activated.

Common use of RC-400 remote controller

RC-400 remote controller can control plural RL-200 2S. When you are using plural RL-200 2S at your job site, you can use your RC-400 for the other RL-200 2S unit. Change the channel to receive the internal data of each RL-200 2S to the RC-400 by operating the RC-400.

This function enables operating of each RL-200 2S, by transmitting and displaying the data of each unit to the remote controller before operation.

See page 33 for the operation “3) Setting channel”.

The RC-400 can also control plural RL-100 2S.

Power Switch

When the power switch on the instrument is turned on, auto-leveling and automatic grade setting will activate.

When using the RC-400 for wireless remote control, also turn the instrument ON or OFF by pressing the power switch on the RC-400.

When transmission had not been correctly performed, “NG” will appear at the lower left of the screen. In such case, please turn the power on once again.

Always turn off the power for the RC-400 before turning off the power for the instrument after the operation. If you forget to turn off the power for the instrument before one for RC-400, the instrument will go into standby mode and the power will not turn off completely.

When the power is not turned off for the instrument.

Standby mode



Instrument will go into standby mode when turning off the power by remote controller.
The power of instrument will turn off completely after keeping standby mode 3 hours.

The channel on the RL-200 2S is not same as one on the RC-400.

- 1** If the channel on the main unit is different from that on the remote control when the power switch is turned ON, the channel on the main unit will be automatically searched for. [SEARCHING...] will be displayed.
- 2** When the search is finished, the available channel and serial number of the instrument will be displayed. If more than one channel is displayed, use the arrow key (up/down) to position the cursor on the channel you want to select. Press the [ENT] key to select that channel.

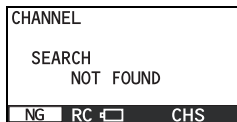

If the message shown left appears, it may indicate that the radio transmission fails. Please turn on the power for the instrument and the remote controller once again.

Battery Status Display

Remaining battery level is displayed at the lower bar in the display area.



Battery remaining display

Rotating laser display: RL
Remote controller display: RC



: Battery is sufficient.



: Battery is sufficient.



: Battery is sufficient.



: The power is low, but laser is still usable.
(Indication continues until batteries are dead.)

RL BATTERY LOW : Dead batteries of RL-200 2S or RC-400. Recharge
or the battery or replace the dry batteries with new ones.
RC-400 BATTERY LOW
(Displayed on the RC-400 only)



If an AC/DC converter is connected to the main instrument when the main instrument is displaying "RL BATTERY LOW", the remaining battery level display will not change. Once the power is turned off, the battery remaining display will reset.

For handling batteries, see the "Maintaining Power Sources" on page 37.

Setting Grades

Grade can be set in both axes, X and Y, as shown below.

Grades can be set in the range indicated below.

X: -10% to +10%

Y: -5% to +25%

Grade axes and axis symbols are as shown in the diagram below.

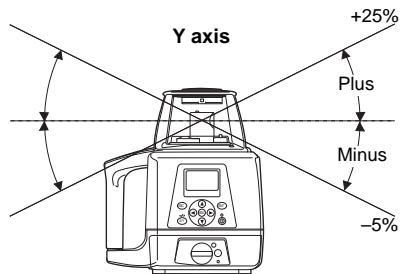
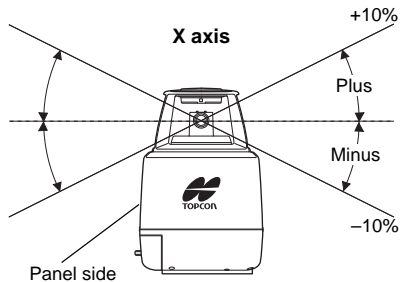

Aligning Direction of Grade

When using the laser with a percent of grade entered, the laser must be properly aligned so the slope of the laser beam is parallel to the desired direction of grade.

The sighting collimator on top of the instrument is calibrated to the grade axis of the laser beam. Follow the steps below to align the laser to the desired direction of grade:

- 1** Establish a target line parallel to desired direction of grade.
- 2** Set up the laser over this line (drop a plumb bob from the tripod mounting screw).
- 3** Rough align the instrument to the direction of grade. Make sure it is properly oriented for the grade to be entered, positive or negative. (See page 26)
- 4** Place a rod or other target down range on the target line.
- 5** While sighting through the collimator, adjust the instrument until the sight is aligned with the target. (See the figures on the right.)

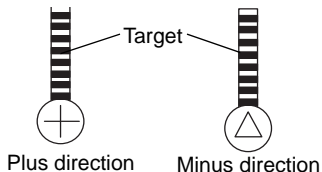
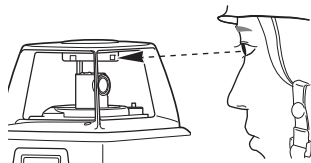
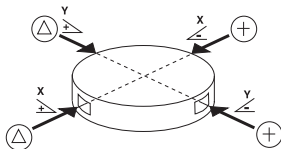

Single axis

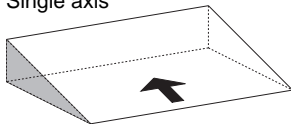

Grade range:
X: -10% to +10%
or
Y: -5% to +25%

Dual axes

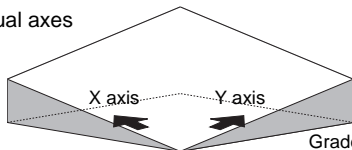

Grade range:
X: -10% to +10%
Y: -5% to +25%

How to Enter Grade

- 1** Press the [X/Y] key to begin grade input.
The axis symbol will flash and it will go into grade entry status.
(The X and Y axis displays will switch with each push.)
- 2** Select positive or negative grade by pressing arrow keys (Up or Down).
- 3** Move the cursor by pressing the arrow keys (Right or Left).
- 4** Increase or decrease the number by pressing the arrow keys (Up or Down).
- 5** Press the [ENT] key to finish input.

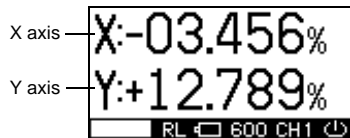

When setting up using the remote controller

Confirm the "OK".

If the "NG" mark is displayed, press the [ENT] key.



When holding down the [X] or [Y] key while the X or Y symbol is flashing, the flashing axis will reset to 00.000%.

Menu

How to Set the Menu

As indicated by arrows in the figure, there are 6 setting categories in the menu and selection and changes of the settings are performed using the arrow keys and [ENT] key.

- 1** Press the menu key to display the menu screen. As you can see, the mask setting is framed with the cursor.
- 2** Move the cursor to the item you would like to set up using the arrow keys and press the [ENT] key. The selected item will start flashing.
- 3** Select the setting details using the arrow keys.
- 4** Press the [ENT] key to lock the setting.
When setting up using the remote controller, make sure that "OK" is displayed on the transmission and reception display. If "NG" is displayed, press the [ENT] key once again.
- 5** In the same manner, select and change the next setting.

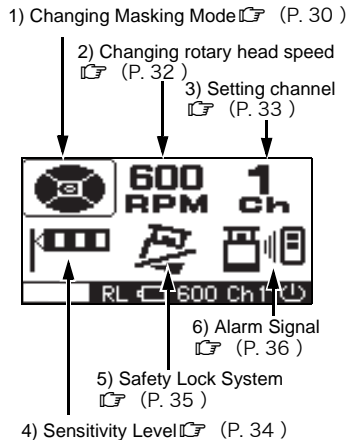

1) Changing Masking Mode

Sets up masking (laser beam shutter) and change shut off directions.

Masking (Laser beam shutter) setting

Depending on the status of the location where the instruments are used, laser beam emission to unnecessary direction can be shut off.

- 1 Press the [MENU] key to display the menu screen.
The mask setting will be displayed on the right in the upper side of the screen.
- 2 Use the arrow keys to position on the Mask display and press the [ENT] key.



- 3 Select the direction you desire to mask using the arrow keys.
Each press repeats mask activating/releasing.
- 4 When desired masking is displayed, press the [ENT] key to finish.
Confirm the [OK] mark on the display.



The state when masking is not activated
(Laser beams are emitted to all directions.)

Displays the masking direction



Displays the direction that laser beam is emitted.

The status in which the X+ direction is masked.
(Laser beam is shut off in the X+ direction.)

When setting up using the remote controller

After completing 1 through 4 of the above setting procedures, check that the transmission and reception display is showing “OK”.

If the [NG] mark is displayed, press [ENT] again. (“OK” and “NG” will be displayed only on the remote controller screen.)

Switching Masking Mode (Split-masking Direction)

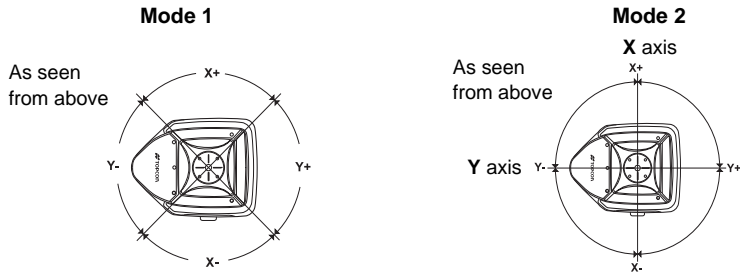

You can select either Mode 1 or Mode 2 for the masking mode.

The relationship between the arrow keys and masking directions are shown in the above figure.

Masking Mode Setting

- 1 Follow steps 1-2 for the masking setting.
- 2 Each press of the [X] or [Y] key toggles Mask Mode 1 and Mask Mode 2.
- 3 Press the [ENT] key to lock the entry. When setting up with the remote controller, make sure that “OK” is displayed on the transmission and reception display. If “NG” is displayed, press the [ENT] key once again.

Sample display



Mode 1



Mode 2

2) How to change the rotary head speed (300, 600, 900 R.P.M.)

The rotary head speed can be set to 300, 600 or 900 R.P.M.

Press the menu key to display the menu screen. Use the arrow keys to select the changing rotary head speed and press the [ENT] key. When the head speed starts flashing, select the desired speed using the arrow keys and press the [ENT] key.

Changing rotary head speed

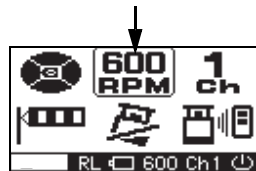

Rotation speed

3) Setting channel

[Setting from the control panel of the instrument]

Only channel on the instrument can be changed.

[Setting from the remote controller]

Only channel on the remote controller can be changed.

[Changing a channel setting by searching] *RC-400 only

- 1** Set channel display to "SEARCH" (Refer to "How to Set the Menu" on page 29), and press the [ENT] key to lock entry.
- 2** Search for the channels available on active or standby RL-200 2S.
When the search is completed, searched channels will be displayed.
- 3** Use the arrow keys (up and down) to position the cursor on the channel you want to select and then press the [ENT] key.



When using more than one units, do not use the same channel at the same time.



You may set the channel from 1 to 9.

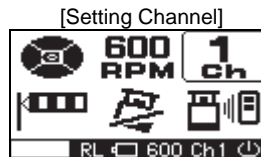

[Channel setting by searching]

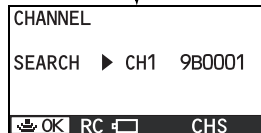
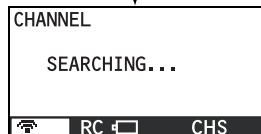

4) Sensitivity Level

The sensitivity level allows the user to select the vibration level that is permitted during auto-leveling or grade setting. Set a sensitivity level to suit the location where the instrument is used such as places that undergo many vibrations, and also in consideration of the operational precision.

Two sensitivity levels can be set: large and small vibrations.

Manual setting will stop the auto-leveling function.

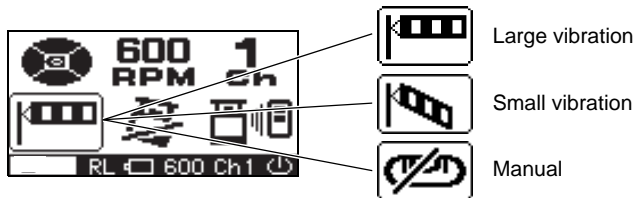

Do not use the manual setting for sensitivity level except in special circumstances. If the manual setting is selected, the auto-leveling function will not operate, so the grading setting precision will not be assured at all. The manual setting will also deactivate the settings for X- and Y-grades.

5) Safety Lock System

When the instrument system detects a shock, this function informs the operate of it. (A safety lock is also called a height alert.)

In case the safety lock system setting is ON, Safety Lock System will active. (This will be active around 10 minutes after turning on the power.)

Should the installed status of the instrument suddenly change when auto-leveling is functioning and laser beam is being emitted, through, for example, unnecessary contact by the user, the auto-leveling function will automatically stop to protect operational precision.

In such a case, the rotary head will act as below:

When [6] Warning transmission] is activated: it will rotate slowly

When [6] Warning transmission] in not activated: the rotation will stop

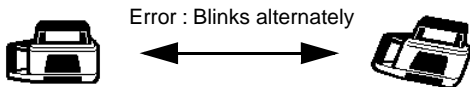
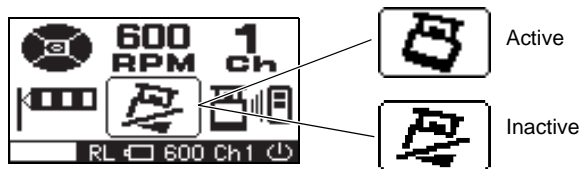

How to reactivate

Turning off the power for the instrument, and then turning it back on will activate the auto-leveling function.

6) Alarm Signal

When used with the Topcon level sensor, the RL-200 2S can communicate alarm signals directly to the sensor. This helps enable the user to be completely aware of potential problems before they can become serious.

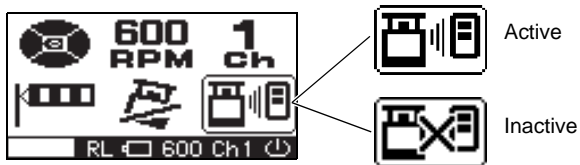

Maintaining Power Sources

How to Change Batteries on the Instrument

Rechargeable battery (BT-67Q)

Installing

- 1 Insert Ni-MH BT-67Q battery pack into the DB-75C battery holder.
- 2 Insert the battery pack into the instrument and turn the battery cover knob to "LOCK".

Charging

- 1 Plug the AC/DC converter AD-11 into the DB-75C battery holder.
- 2 Plug the converter power cord into the appropriate AC outlet.
- 3 When charging is complete (after approximately seven hours), unplug the converter from the connector on the DB-75C battery holder.
- 4 Unplug the converter power cord from the AC receptacle.

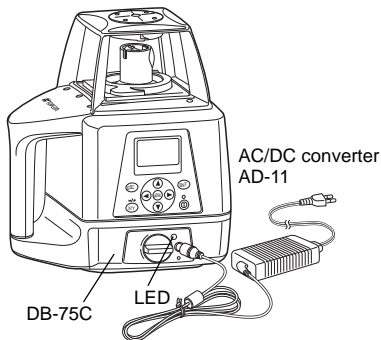

The LED of DB-75C will indicate charging status:

Red ON : Charging.

Green ON : Charging completed.

Green flashing : Ni-MH BT-67Q battery pack is not installed correctly.

Red flashing : Ni-MH BT-67Q battery pack protection feature is working automatically.
RL-200 2S can be used in this state.

The instrument has a protection feature which works when nickel hydride batteries are overcharged or when the batteries are under a high or low temperature (+70°C or higher, or 0°C or lower) state. In such a case, charging will stop automatically to protect nickel hydride batteries.



Recharging should be performed in a room temperature ranging from +10°C to +40°C. Always use the AC/DC converter provided with the product.



- 1) The Ni-MH BT-67Q rechargeable battery can be charged while using the laser.
- 2) The Ni-MH BT-67Q rechargeable battery can be charged when the battery holder is removed from the instrument. This allows the option of alternately using two battery packs to always maintain a fully charged pack.
- 3) The Ni-MH BT-67Q rechargeable battery can be removed from the DB-75C battery holder and 4xD size dry cell batteries (alkaline) can be installed.
- 4) The DB-75 dry cell battery holder cannot be used to charge the BT-67Q Ni-MH battery pack. Use the DB-75C charging battery holder instead.

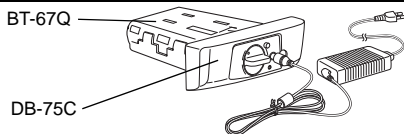



- 1) For longer battery life, conform to the suggested charging time to the extent possible.
- 2) The battery source will discharge when stored and should be checked before using with instrument.
- 3) Be sure to charge stored battery source every 3 or 6 months and store in a place at 30 °C or below.

If you allow the battery to become completely discharged, it will have an effect on future charging.

Dry battery

How to replace dry batteries

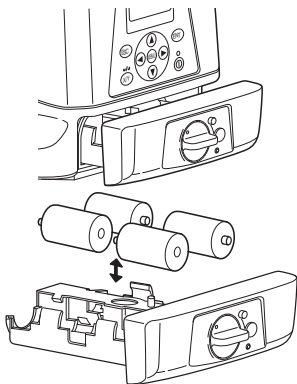

- 1** Remove the battery cover by turning the battery cover knob to "OPEN".
- 2** Remove the old batteries and replace with new batteries (4xD size dry cell batteries) matching [+] and [-] as shown in the figure.
- 3** Replace the battery cover and turn the knob to "LOCK".



Replace all 4 batteries with new ones.
Do not mix old batteries and new ones.

How to Replace the RC-400 Batteries

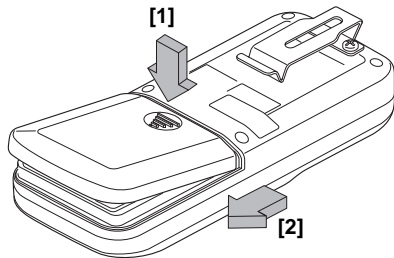

- 1** Keep pushing the battery cover in [1] direction, and then try to slide the cover in [2] direction. The cover does not move but it will be open.
- 2** Remove the old batteries and replace with new batteries (three AA batteries), matching [+] and [-] as shown in the figure.
- 3** Replace the battery cover.



Replace all 3 batteries with new ones.
Do not mix old batteries and new ones.

Check and Adjusting

Horizontal Calibration

(1) Checking Calibration

1 Steadily set up a tripod approximately 50m from a staff member or wall and adjust so that the head of the tripod is horizontal.

Mount the instrument on the tripod in the direction shown in the right figure (Y-axis facing the wall).

2 While pressing the [X] or [Y] key, turn on the power switch.

3 The flashing axis is the selected one. Select the axis to check using the arrow keys (right and left) and press the [ENT] key to lock.

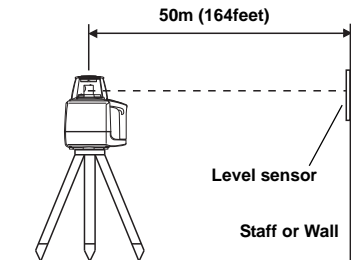
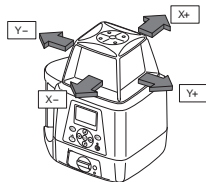

Turn on the power while pressing the [X] or [Y] key.



Select the axis using the arrow keys (right and left) and press the [ENT] key.



(Example: Y axis)

- 4** Select Y axis by pressing the right arrow key.
Press the [ENT] key to lock.
- 5** "POSITION 1" display will flash and the instrument will begin auto-leveling. After the auto-leveling is completed, the "POSITION 1" light will turn on, then, the rotary head rotates and emits laser beam. (Y-).
- 6** Turn on the power for the level sensor, and press the detective precision switch to select the high detection mode.
- 7** Check the position of the laser beam (Y-) on the wall.
Move the sensor up or down until the LCD indicator identifies the center of the laser beam.
- 8** After fixing the beam, press the [ENT] key.
The display will change to flashing "POSITION 2".

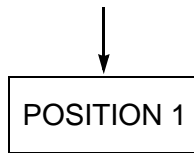

Check the laser beam on the wall.

Fix the level sensor in the position where the LCD indicator identifies the center of the laser beam.

Press the [ENT] key after check.

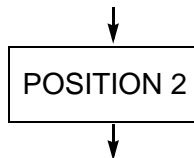

9 Loosen the tripod and rotate the instrument 180° and retighten to fix. The Y+ side of the instrument should be facing the wall. After the auto-leveling is completed, the display will change to [▲][▼], then, the rotary head rotates and emits laser beam.

10 Following step 7, mark the laser beam position for (Y+).

If the two lasers being marked are misaligned for less than 3.5mm, adjustment is not necessary. Turn off the power for the instrument. If adjustment is required, move on to (2) How to adjust.

(2) How to adjust

After completing the checking in step 10, go on to the adjustment specified below.

- 1 Using the arrow keys (up and down), adjust the (Y+) laser beam to the center of (Y-) and (Y+).
- 2 Press the [ENT] key when the laser beam is correctly positioned in the center.



Check the misalignment of laser beam of (Y+) and (Y-) on the wall.

If one of the 3 center indicators is lit, calibration is normal.

Misalignment of (Y-) and (Y+) laser beam within 3.5mm is considered normal.

Turn off the power to complete the checking.



When rotating the instrument 180°, ensure that the height of the instrument is aligned.



By using the up and down arrow keys of the remote controller, adjust the (Y+) laser beam to the center of the (Y-) and (Y+).

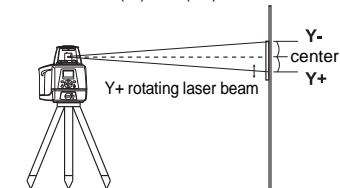

- 3** “CALCULATING” will flash indicating that the calibration value is being calculated by the instrument. Do not touch the instrument until “END” is displayed to signify operation completed. (If you touch the instrument, you will need to recalibrate.)
- 4** When “END” is displayed, press the [ENT] key. The screen will return to the axis selection screen. If you wish to continue with checking the X axis, go back to step 3 for calibration check.
- 5** When you have completed the adjustment, turn off the power. After adjustment is completed, go through the checking procedure to check if the adjustment was done accurately.

After positioning the laser beam, press the [ENT] key.

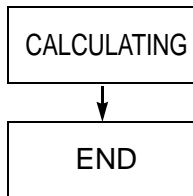

After calibration value is fixed, press the [ENT] key.

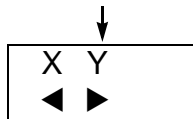

The screen goes back to the axis selection screen.



If the correction value calculated exceeds the allowable range, the RL-200 2S will display error code [CALIBRATION OVER ERR]. Check the procedure again and perform any inspections and adjustments.

If this error code is displayed again, repair is required. Contact your dealer or Topcon.

Horizontal Rotation Cone Error

Perform the following check after completing “Horizontal Calibration” on the previous page.

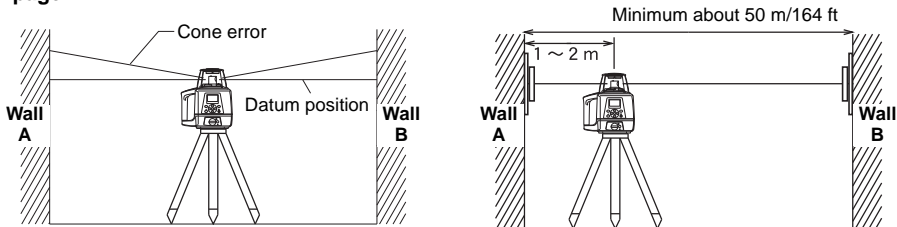

- 1 Set up the laser centered between two walls approximately 50 m (164 ft) apart. Orient the instrument so one axis, either X or Y, is facing the walls. Grade should be set to 0.00% in both axes.
- 2 Locate and mark the position of the rotating laser beam on both walls using the level sensor.
- 3 Turn off the instrument and move the instrument closer to wall A (1 m to 2 m / 3 ft to 6 ft). Do not change the axis orientation of the instrument. Turn the instrument on.
- 4 Again locate and mark the position of the rotating laser beam on both walls using the level sensor.
- 5 Measure the distance between the first and second marks on each wall.
- 6 If the difference between each set of marks is less than ± 5 mm ($\pm 7/32$ of an inch), no error exists.



If the difference between [wall A]-side and [wall B]-side exceeds ± 5 mm ($\pm 7/32$ of an inch), contact your dealer or Topcon.

Grade Setting Error

Perform the following check only after completing “Horizontal Calibration” and “Horizontal Rotation Cone Error”.

(1) Checking

1 Setup the Y+ side facing the staff as shown in the figure.

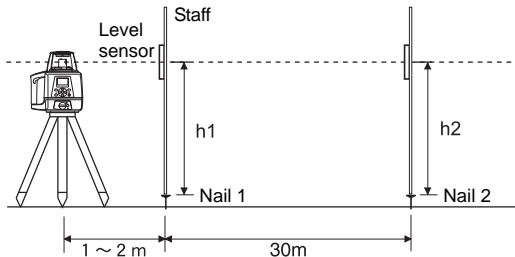

Securely position Nail 1 and Nail 2 exactly 30m apart.

2 Turn on power for the instrument and verify the staff height of Nail 1 and Nail 2 at grade setting of 0% with level sensor and record.

At this time the staff height for Nail 1 and Nail 2 should recorded as h_1 and h_2 (mm). Check the level sensor is set at high precision.

3 Set Y axis grade to -1.000%.

Align read the elevation of the laser beam in millimeters at Nail 1 and Nail 2.

Designate these elevations as “h3” at Nail 1, and “h4” at Nail 2.

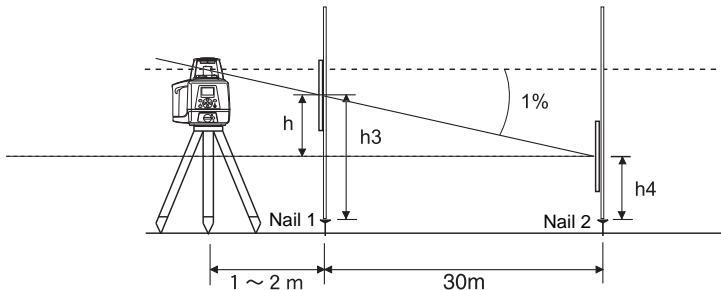

4 Using the elevation readings for h1, h2, h3 and h4, complete the equation below.

$$Y(\%) = \frac{h}{30000(\text{mm})} \times 100 = \frac{(h1-h3)-(h2-h4)}{30000} \times 100$$

If the calculated result is the range of -0.990% to -1.010%, the instrument is normal.

If the calculated result for either axis is out of the range, contact your dealer or Topcon.

Repeat the procedure aligning the “X” axis on the line created by Nail 1 and Nail 2.

Storage Precautions

- (1) Always clean the instrument after use.
 - 1) If the instrument got wet with rain, wipe it well before storing in the storage case.
 - 2) Wipe away stain or dirt with soft cloth after dusting.

- (2) Clean storage case using cloth moistened with neutral detergent or water. Do not use ether, benzene, thinner or other solvents.

- (3) Store with the batteries removed, when operation is halted for more than a month.

Standard Accessories

Level sensor holder model 6

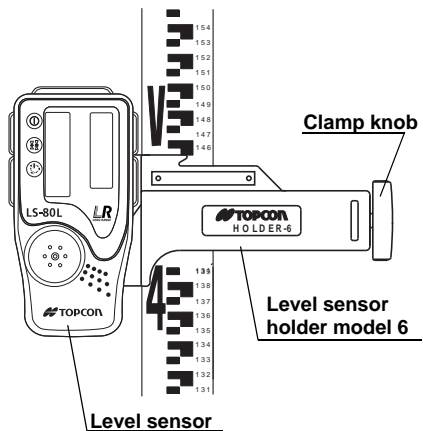

Level Sensor LS-80L

Power switch

The power switch turns ON or OFF by pressing.

On-Grade precision switch

Two on-grade precision options are available, normal precision ($\pm 2\text{mm}$) and high precision ($\pm 1\text{mm}$). By pressing this switch, the precision options are switched alternately. Confirm the precision choice by the indicator. (Normal precision is the default setting each time the sensor is turned on.)

Buzzer sound switch

Volume of the sensor buzzer can be alternately switched to LOW/LOUD/OFF by pressing the switch.

Auto-cut off function

The power will be turned off automatically if no laser beam is detected for approximately 30 minutes. (To turn on the level sensor, press the power switch again.)

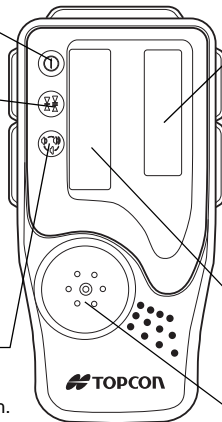

Indicator LS-80L Display (P. 52)

Detect the on-grade position "----" by moving the LS-80L up and down. Directional arrows and audio signals assist in locating the on-grade position as the laser strikes the beam receiving window. (Top of LS-80L is 40mm (1 9/16") from on-grade index for offset marking.)

The indicators are located on front and back sides of the instrument.

Index

Beam receiving window

Turn the beam receiving window side towards RL-200 2S to detect the laser beam.

Buzzer speaker

LS-80L Display

Height alert warning of rotating laser*1

A flash and a buzzer sound signifies that the height alert function of the RL-200 2S is operating.

Rotating laser battery warning*2

A flash shows that the RL-200 2S power is low.

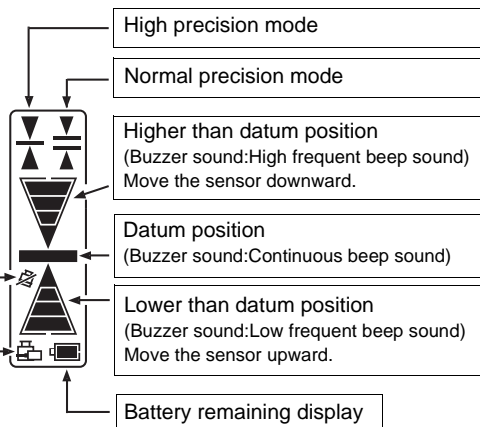

The warning displays *1 and *2 are the functions that the LS-80L detects alarm signal from the RL-200 2S. The LS-80L can be canceled the alarm detection from the RL-200 2S. To be canceled the detection; Press the power switch while pressing the buzzer sound switch when powering on.

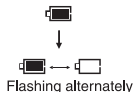









Battery is sufficient.

The power is low, but laser is still usable.

Dead battery.
Replace the dry battery with new one.

Detective range

Display	Precision
	<p>  High $\pm 1\text{mm}$ (2mm width) </p> <p>  Normal $\pm 2\text{mm}$ (4mm width) </p>
	<p>$\pm 5\text{mm}$ (10mm width)</p>
	<p>$\pm 10\text{mm}$ (20mm width)</p>
	<p>$\pm 15\text{mm}$ (30mm width)</p>
	<p>more than $\pm 15\text{mm}$ (more than 30mm width)</p>
	<p>Level sensor is moved upward or downward from laser beam.</p>

Replacing Battery

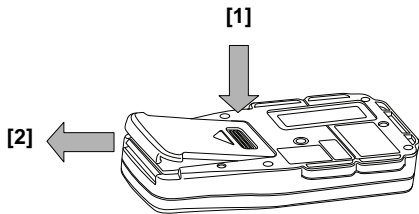

- 1** Keep pushing the battery cover in 1 direction, and then try to slide the cover in 2 direction. The cover does not move but it will be open.
- 2** Take out the old batteries and replace with new ones into the battery box.
- 3** Press the lid down and click to close.

Specifications

RL-200 2S

Accuracy	: $\pm 7''$
Auto-leveling range	: $\pm 5^\circ$
Measuring range (Diameter)	: Approx. 2 – 1100 m (6 - 3608.9 ft) with LS-80L
Rotation speeds	: 300/600/900 rpm (Changeable)
Light source	: L.D. (Visible laser)
Power supply	: 4xD size dry cell batteries (alkaline) Ni-MH battery pack BT-67Q (It can be charged while using it.)
Operating time (+20°C / +68°F)	: Approx. 100 hours (Alkaline manganese dry battery) Approx. 90 hours (Ni-MH battery pack BT-67Q)
Tripod screw	: Flat and dome head type, W 5/8"x11 threads
Protection against water and dust	: IP66 (Based on the standard IEC60529)
Operating temperature	: -20 °C to +50 °C (-4 °F to +122 °F)
Storage temperature	: -30 °C to +60 °C (-22 °F to +140 °F)
Dimensions	: 174 (L) × 218 (W) × 253 (H) mm [6.9 (L) × 8.6 (W) × 10.0 (H) in]
Laser beam height	: 209mm (Height from the instrument's bottom surface to the center point of laser beam)
Weight	: 3.4kg (7.5lbs) (Dry battery type: Including dry cell batteries) 3.6kg (7.9lbs) (Ni-MH battery type: Including BT-67Q)







RC-400

Power source	: 3xAA size dry cell batteries (alkaline)
Operating distance	: Approx. 300m
Operating time (+20°C / +68°F)	: Approx. 3 months (Alkaline manganese dry battery) (Life of battery may significantly shorten in the cold region.)
Operating temperature	: -20 °C to +50 °C (-4 °F to +122 °F)
Storage temperature	: -30°C to +60°C (-22°F to +140°F)
Dimensions	: 157 (L) x 64 (W) x 37 (H) mm [6.8 (L) x 2.5 (W) x 1.4 (H) in]
Weight	: 0.25kg (0.5lbs) (Including dry cell batteries)

LS-80L

Beam detection window	: 50 mm (2.0 in)
Beam detection precision	
High precision	: ±1 mm (±0.04 in)
Normal precision	: ±2 mm (±0.08 in)
Beam detection indication	: Liquid crystal (both sides) and buzzer
Power source	: 2xAA size dry cell batteries (alkaline)
Operating time (+20°C / +68°F)	: Approx. 120 hours (Using alkaline manganese dry cell batteries)
Auto-cut off delay	: Approx. 30 minutes without beam detection
Protection against water and dust	: IP66 (Based on the standard IEC60529)
Operating temperature	: -20°C to +50°C (-4°F to +122°F)
Storage temperature	: -30°C to +60°C (-22°F to +140°F)
Dimensions	: 146(L) x 76(W) x 26(H)mm (5.7 x 2.9 x 1.0 in)
Weight	: 0.19 kg [0.41 lbs] (including dry cell batteries)

Error Display

Error Code	Description	Countermeasure
 RL BATTERY LOW	Batteries of the instrument are dead.	Replace the batteries of the instrument.
 RC-400 BATTERY LOW	Batteries of the remote controller are dead.	Replace the batteries of the remote controller.
	Safety lock system is activated.	Turn the power for the instrument off, and then turn it back on to activate auto-leveling function.
	The instrument is set up exceeding the auto-leveling range.	Reposition the instrument to fit into the auto-leveling range in the direction specified.
		
		
		
CALIBRATION OVER ERR	Checking mode identified as being exceeding calibration range.	Turn the power for the instrument; turn it back on and start over from the beginning.

Error Code	Description	Countermeasure
E-05	The rotary head is not rotating	Turn the power for the instrument off, and then turn it back on.
E-51	Internal memory error for the remote controller	Turn the power for the remote controller off, and then turn it back on.
E-60's	Encoder system error for the instrument	Turn the power for the instrument off, and then turn it back on.
E-80's	Auto-leveling is not completed	Turn the power for the instrument off, and then turn it back on.
E-99	Internal memory error for the instrument	Turn the power for the instrument off, and then turn it back on.
LCD backlight is flashing	Cannot be displayed	Turn the power for the instrument off, and then turn it back on.

If errors still persist after attempting to clear them, contact Topcon or your dealer.

Regulations

Region/ Country	Directives/ Regulations	Labels/Declarations
U.S.A.	FCC	<p>FCC Compliance</p> <p>This device complies with Part 15 of the FCC Rules. Operation is subject to the following two conditions: (1) This device may not cause harmful interference, and (2) this device must accept any interference received, including interference that may cause undesired operation.</p> <p>Contains FCC ID: PH3XE972</p> <p>NOTE:</p> <p>This equipment has been tested and found to comply with the limits for a Class A digital device, pursuant to part 15 of the FCC Rules. These limits are designed to provide reasonable protection against harmful interference when the equipment is operated in a commercial environment. This equipment generates, uses, and can radiate radio frequency energy and, if not installed and used in accordance with the instruction manual, may cause harmful interference to radio communications. Operation of this equipment in a residential area is likely to cause harmful interference in which case the user will be required to correct the interference at his own expense.</p> <p>This equipment should be installed and operated with at least 20cm and more between the radiator and person's body (excluding extremities: hands, wrists, feet and ankles).</p>

WARNING:

Change or modifications not expressly approved by the party responsible for compliance could void the user's authority to operate the equipment. Specified cables must be used for connection to computer and/or peripherals in order to meet FCC emission limits.

CAUTION:

This device and its antenna(s) must not be co-located or operating in conjunction with any other antenna or transmitter. End user cannot modify this transmitter device. Any unauthorized modification made on the device could avoid the user's authority to operate this device.

Declaration of Conformity

Model Number:RL-200 2S, RC-400

Trade Name:TOPCON CORPORATION

Manufacture

Name: TOPCON CORPORATION

Address: 75-1, Hasunuma-cho, Itabashi-ku, Tokyo, 174-8580 JAPAN

Country: JAPAN

U.S.A. Representative

Responsible party:TOPCON POSITIONING SYSTEMS,INC.

Address: 7400 National Drive Livermore, CA94551, U.S.A

Telephone number:925-245-8300

Region/ Country	Directives/ Regulations	Labels/Declarations
California, U.S.A.	Proposition65	<div data-bbox="628 187 1228 281" style="border: 1px solid black; padding: 5px;"> <p>WARNING : Handling the cord on this product or cords associated with accessories sold with this product, will expose you to lead, a chemical known to the State of California to cause birth defects or other reproductive harm. <i>Wash hands after handling.</i></p> </div>

California,
and NY,
U.S.A.

Recycling
Batteries

DON'T THROW AWAY RECHARGEABLE BATTERIES, RECYCLE THEM.

**Topcon Positioning Systems Inc., United States Return Process
for Used Rechargeable Nickel Metal Hydride, Nickel Cadmium,
Small Sealed Lead Acid, and Lithium Ion, Batteries**

In the United States Topcon Positioning Systems Inc., has established a process by which Topcon customers may return used rechargeable Nickel Metal Hydride (Ni-MH), Nickel Cadmium (Ni-Cd), Small Sealed Lead Acid (Pb), and Lithium Ion (Li-ion) batteries to Topcon for proper recycling and disposal. Only Topcon batteries will be accepted in this process.

Proper shipping requires that batteries or battery packs must be intact and show no signs of leaking. The metal terminals on the individual batteries must be covered with tape to prevent short circuiting and heat buildup or batteries can be placed in individual plastic bag. Battery packs should not be disassembled prior to return.

Topcon customers are responsible for complying with all federal, state, and local regulations pertaining to packing, labeling, and shipping of batteries. Packages must include a completed return address, be prepaid by the shipper, and travel by surface mode. **Under no circumstance should used/recyclable batteries be shipped by air.**

Failure to comply with the above requirements will result in the rejection of the package at the shipper's expense.





Please remit packages to: Topcon Positioning Systems, Inc.
C/O Battery Return Dept. 150
7400 National Dr.
Livermore, CA 94551

DON'T THROW AWAY RECHARGEABLE BATTERIES, RECYCLE THEM.

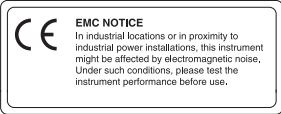
Region/ Country	Directives/ Regulations	Labels/Declarations
Canada	ICES	<p>This Class A digital apparatus complies with Canadian ICES-003. Cet appareil numérique de la classe A est conforme à la norme NMB-003 du Canada.</p> <p>This equipment should be installed and operated with at least 20cm and more between the radiator and person's body (excluding extremities: hands, wrists, feet and ankles).</p> <p>Contains IC: 3070C-XE972</p> <p>The term "IC:" before the radio certification number only signifies that Industry Canada technical specifications were met.</p> <p>"Operation is subject to the following two conditions: (1) this device may not cause interference, and (2) this device must accept any interference, including interference that may cause undesired operation of the device."</p> <p>L' utilisation de ce dispositif est autorisée seulement aux conditions suivantes : (1) il ne doit pas produire de brouillage et (2) l' utilisateur du dispositif doit être prêt à accepter tout brouillage radioélectrique reçu, même si ce brouillage est susceptible de compromettre le fonctionnement du dispositif.</p>

		<p>“The installer of this radio equipment must ensure that the antenna is located or pointed such that it does not emit RF field in excess of Health Canada limits for the general population; consult Safety Code 6, obtainable from Health Canada’s website www.hc-sc.gc.ca/rpb”</p> <p>“This device has been designed to operate with the antennas listed below, and having a maximum gain of 0.61dB. Antennas not included in this list or having a gain greater than 0.61dB are strictly prohibited for use with this device. The required antenna impedance is 50 ohms.”</p> <p>“To reduce potential radio interference to other users, the antenna type and its gain should be so chosen that the equivalent isotropic ally radiated power (e.i.r.p.) is not more than that permitted for successful communication.”</p>
Australia	C-Tick	 <p>The compliance label indicates that the product complies with the applicable standard and establishes a traceable link between the equipment and the manufacturer, importer or their agent responsible for compliance and for placing it on the Australian market.</p>

Region/ Country	Directives/ Regulations	Labels/Declarations
EU	R&TTE CE	 <p>CE EMC NOTICE In industrial locations or in proximity to industrial power installations, this instrument might be affected by electromagnetic noise. Under such conditions, please test the instrument performance before use.</p>
EU	R&TTE	<p>R&TTE Directive ROTATING LASER RL-200 2S, REMOTE CONTROLLER RC-400 Hereby, TOPCON CORP., declares that the above-mentioned equipment is in compliance with the essential requirements and other relevant provisions of Directive 1999/5/EC. Please inquire below if you wish to receive a copy of Topcon's Declaration of Conformity. Topcon Europe Positioning B.V. Essebaan 11, 2908 LJ Capelle a/d IJssel, The Netherlands Tel:+31-10-4585077 Fax:+31-10-2844949 http://www.topcon-positioning.eu/index.asp</p>

Region/ Country	Directives/ Regulations	Labels/Declarations
EU	WEEE Directive	<div style="border: 1px solid black; padding: 10px;">  <p>WEEE Directive  This symbol is applicable to EU members states only.</p> <p>Following information is only for EU-member states: The use of the symbol indicates that this product may not be treated as household waste. By ensuring this product is disposed of correctly, you will help prevent potential negative consequences for the environment and human health, which could otherwise be caused by inappropriate waste handling of this product. For more detailed information about the take-back and recycling of this product, please contact your supplier where you purchased the product or consult.</p> <p style="text-align: right;">TOPCON CORPORATION</p> </div>
EU	EU Battery Directive	<div style="border: 1px solid black; padding: 10px;">  <p>EU Battery Directive  This symbol is applicable to EU members states only.</p> <p>Battery users must not dispose of batteries as unsorted general waste, but treat properly.</p> </div>

TOPCON CORPORATION

75-1 Hasunuma-cho, Itabashi-ku, Tokyo 174-8580, Japan <http://www.topcon.co.jp>

Please see the attached address list or the following website for contact addresses.

GLOBAL GATEWAY <http://global.topcon.com/>
